

2D IMAGING



Welcome

An introduction from our President

Industry-leading 2D X-ray units	4
Planmeca ProMax® 2D	6
The benchmark for extraoral imaging	6
Effortless and comfortable	8
Robotic arm technology	10
All the imaging programs you need	12
Quality cephalometry for orthodontics	14
Easy upgrade from 2D to 3D	16
Planmeca ProOne®	18
Simplicity at its finest	18
Optimal imaging programs	20
Planmeca ProX™	22
Flexible intraoral X-ray unit	22
Planmeca ProSensor® HD	24
Innovative intraoral sensor	24
Planmeca ProScanner® 2.0	26
User-friendly and reliable imaging plate scanner	26
Planmeca Romexis® – one software for all your needs	28
High-performance 2D imaging	30
Share images and expertise online	32
Technical specifications	34

“It’s my great pleasure to introduce you to our pioneering 2D X-ray units. Our comprehensive range of digital units meets all your daily imaging needs – working perfectly with our highly advanced **Planmeca Romexis®** software for the most detailed extraoral and intraoral examinations possible.

I’m extremely proud of our product innovations, and for over 45 years we’ve worked closely with dental professionals to set new standards in our field. What makes us a bit different is that all core product development and manufacturing takes place at our headquarters in Helsinki, Finland – ensuring exceptional quality and unmatched attention to detail at every stage of the process.

We also have a dedicated team of R&D professionals behind the scenes, developing breakthrough innovations that make a real difference. Our robotic SCARA technology, for example, offers flexible, precise and complex movements needed for extraoral maxillofacial imaging. Our **Planmeca ProMax® 2D** X-ray units are all 3D-ready, which means you can easily upgrade at a later point.

I am thrilled to invite you to discover our world of 2D imaging!”

Heikki Kyöstiä
President and founder
Planmeca Group



Industry-leading 2D X-ray units

Explore our world-class range of 2D imaging equipment – offering the most advanced and versatile features and software to meet all your 2D extraoral and intraoral imaging needs.



Planmeca ProSensor® HD



Planmeca ProScanner® 2.0



Planmeca ProMax® 2D

Planmeca ProMax[®] 2D

The benchmark for extraoral imaging

Planmeca ProMax[®] is a complete maxillofacial imaging system. The design and operation principles are based on the latest scientific research, technological innovations and the most demanding needs of modern-day radiology.

Different models for different needs

Planmeca ProMax[®] 2D S3

The three-joint model (SCARA3) **Planmeca ProMax[®] 2D S3** has been designed for all imaging needs: panoramic, true extraoral bitewing, TMJ, sinus and 2D tomography.

Planmeca ProMax[®] 2D S2

The two-joint model (SCARA2) **Planmeca ProMax[®] 2D S2** includes basic programs for panoramic, extraoral bitewing, TMJ and sinus imaging.

Key features

Advanced technology

- Autofocus positions the focal layer automatically for perfect panoramic images
- Dynamic Exposure Control (DEC) measures the patient's radiation transparency and automatically adjusts exposure values
- Patented SCARA (Selectively Compliant Articulated Robot Arm) technology guarantees an anatomically accurate imaging geometry for clear, error-free images
- Easy upgrades – add cephalostat or 3D imaging capability at any time

Effortless use

- Full-view patient positioning with triple-laser patient positioning lights
- Side entry for comfortable access
- Easy-to-use graphical interface
- **ProTouch[™] Desktop** for remote control panel operation on the imaging workstation
- Versatile **Planmeca Romexis[®] 2D** imaging software
- TWAIN support and full DICOM compliance



	ProMax 2D S3	ProMax 2D S2
Panoramic imaging	✓	✓
Cephalometric imaging, scanning	✓	✓
Cephalometric imaging, one-shot	✓	
True extraoral bitewing	✓	
Extraoral bitewing		✓
TMJ imaging	✓	✓
Sinus imaging	✓	✓
Tomographic imaging	✓	
Child mode	✓	✓
Autofocus	✓	
3D upgradeability	✓	
Robotic technology, three-joint model (SCARA3)	✓	
Robotic technology, two-joint model (SCARA2)		✓

Effortless and comfortable

Our industry-leading **Planmeca ProMax®** unit is known across the world for incredible ease of use and exceptional patient comfort. A relaxed patient means a smooth imaging workflow and the best possible image quality.



Open patient positioning

- Position patients effortlessly thanks to open-face architecture
- Correct patient positioning either with Autofocus or manually
- Make fine adjustments using positioning lasers and joystick
- Work with an unrestricted view of your patient
- Avoid claustrophobic feelings in patients
- Accommodate wheelchairs easily with side-entry access

Laser-assisted patient alignment

- A triple laser beam system accurately indicates the correct anatomical alignment points for patient positioning
- The midsagittal plane positioning beam indicates the correct sideways alignment
- The Frankfort horizontal plane positioning beam shows the correct forward tilt of your patient's head
- The focal layer positioning beam indicates the focal layer position and ensures images are sharp and clear
- Fine adjustments can be made using the joystick

User-friendly control panel

- Clear and straightforward graphical user interface guides you smoothly through your work
- Pre-programmed sites and exposure values for different image types and targets save you time and allow you to focus on your patients
- The control panel can also be operated remotely from the imaging workstation

Improved image quality with Dynamic Exposure Control (DEC)

The unique digital Dynamic Exposure Control (DEC) automatically adjusts the exposure values for each individual patient based on their anatomic structure and bone density. DEC improves the quality of both panoramic and cephalometric imaging with more consistent brightness and contrast.

Adjustable focal layer

Developed based on scientific research, the imaging geometry matches the shape of the focal layer with the patient's anatomy, resulting in clear panoramic radiographs. Simply select the shape of the focal layer on the graphical user interface, according to the size and shape of the patient's jaw.

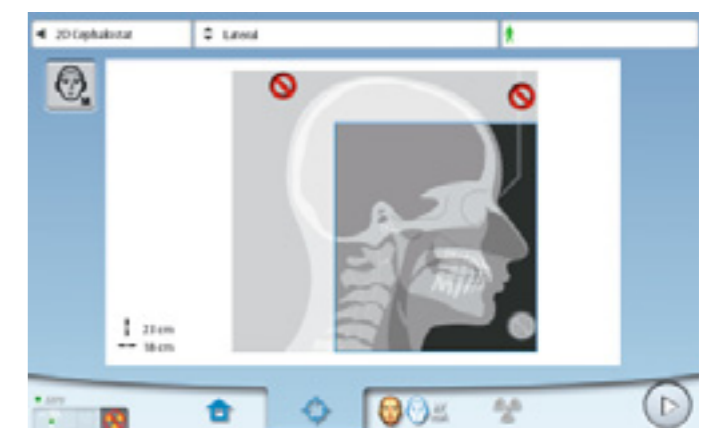
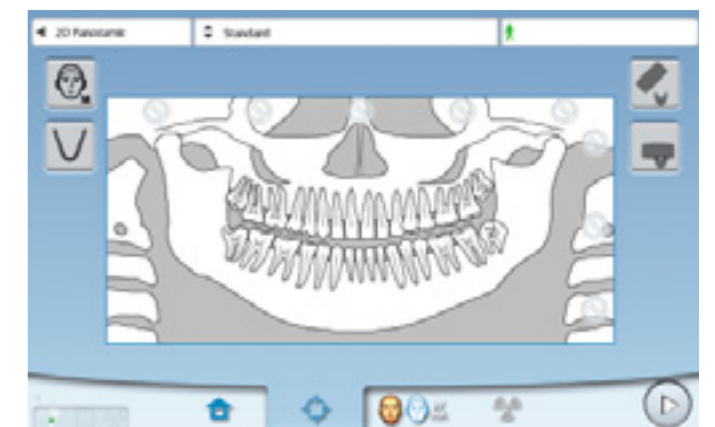

Robotic arm technology

Planmeca ProMax® features highly advanced and exclusive robotic SCARA (Selectively Compliant Articulated Robot Arm) technology – providing flexible, precise and complex movements required for rotational maxillofacial imaging.



Unlimited movement range

Our revolutionary SCARA technology combines an electro-mechanical construction with real-time computation of dynamic rotation patterns. This enables optimised radiography for each individual patient, meeting virtually any diagnostic requirement for maxillofacial dentistry.

User benefits for SCARA

The precise free-flowing arm movements allow for a wider variety of imaging programs not possible with other X-ray units with fixed rotations. SCARA offers superior imaging capabilities for both existing and future technologies.

Perfect panoramic images – every time

Positioning errors are now a thing of the past – with SCARA technology you can take an ultra-low-dose scout image of your patient's central incisors for a fast diagnostic panoramic image every time.

Two options

- The three-joint model (SCARA3) **Planmeca ProMax® 2D S3** for all imaging needs.
- The two-joint model (SCARA2) **Planmeca ProMax® 2D S2** for basic imaging needs.

Special features only possible with our SCARA3 technology

X-ray unit recognises your patient's anatomy

The unique **Autofocus** feature automatically positions the focal layer using a low-dose scout image of the patient's central incisors. It uses landmarks in the patient's anatomy to calculate placement, enabling practically error-free patient positioning and dramatically reducing the need for retakes. The result is a perfect panoramic image.

Better diagnostic value with extraoral bitewings

- Ideal for all patients – no sensor positioning required
- Consistently opens interproximal contacts, giving better diagnostic value
- Larger diagnostic area than in intraoral modalities
- More clinical data: canine to third molar
- Enhanced clinical efficiency – takes less time and effort than conventional intraoral bitewings
- Enhanced patient experience and comfort – eliminates gagging



All the imaging programs you need



Standard panoramic

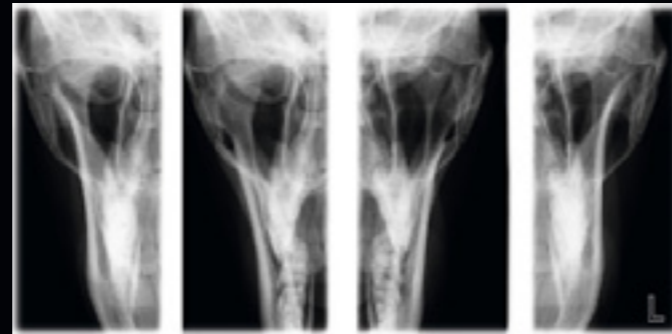

PA TMJ (closed & open)

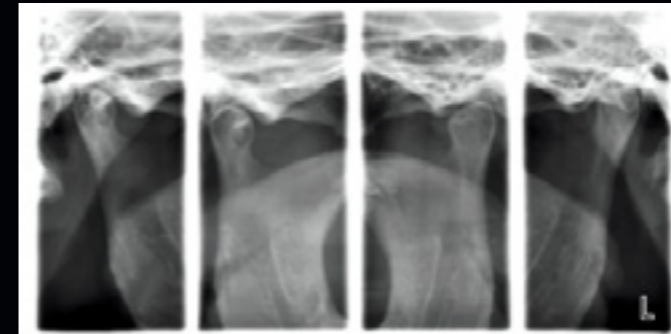

Lateral TMJ (closed & open)

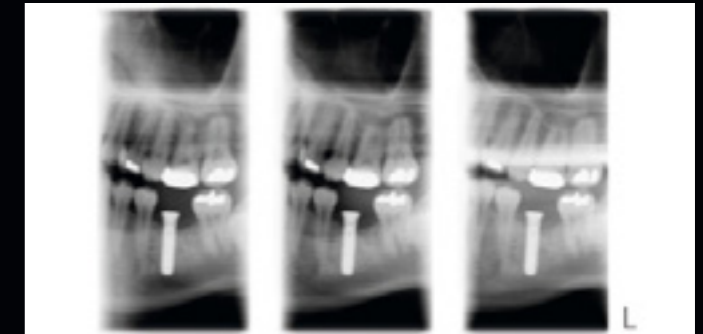

Longitudinal tomography

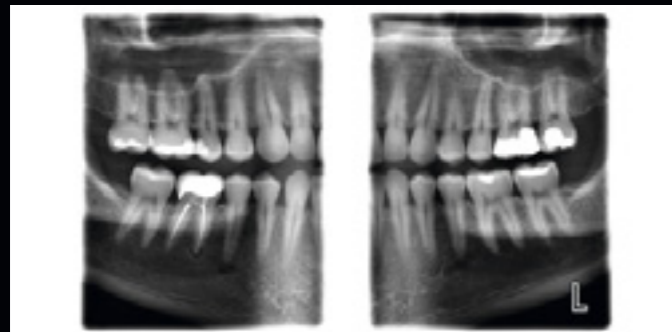

True bitewing



Horizontal and vertical segmenting

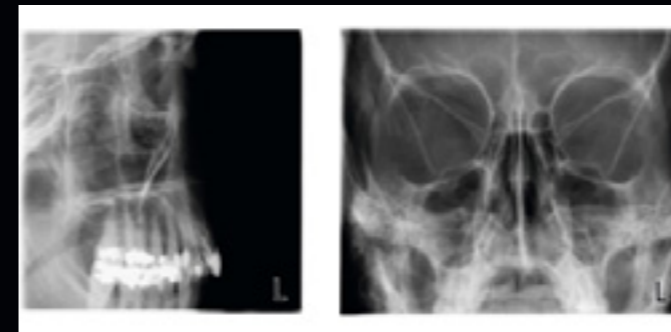

Lateral sinus and PA linear sinus

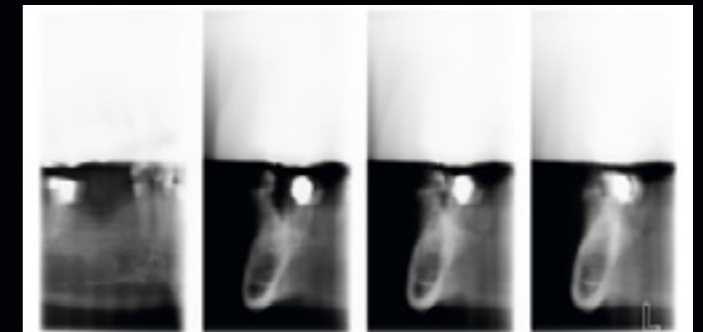

Combined tomography

Our Planmeca ProMax® X-ray unit offers the widest variety of imaging programs available – easily meeting all your clinical needs.

Panoramic imaging

In addition to the Standard panoramic program, the following programs are offered:

- Interproximal panoramic program: generates an image, where interproximal teeth contacts are open. Primarily used for caries detection.
- Orthogonal panoramic program: produces an image with clearly visible alveolar crest for improved diagnostics. Ideal for periodontal imaging and implant planning.

Extraoral bitewings

The Bitewing program uses improved interproximal angulation geometry. The result is a bitewing image pair with low patient dose and excellent diagnostic quality.

Horizontal and vertical segmenting for panoramic program

With the Horizontal and vertical segmenting program, exposure can be strictly limited to the diagnostic region of interest. Patient dosage is reduced by up to 90% compared to full panoramic exposure.

TMJ imaging

The TMJ imaging programs produce lateral or posteroanterior views of open or closed temporomandibular joints. The imaging angle and position can be adjusted to correspond to the anatomy of each individual patient.

The Lateral-PA TMJ program captures lateral and PA views on the same radiograph. The multi-angle TMJ programs produce radiographs with images from three different angles, from either the lateral or PA view.

Sinus imaging

The Sinus programs provide a clear view of the maxillary sinuses.

Tomographic imaging

Planmeca ProMax® 2D tomography programs provide accurate tomographic information for the analysis, planning and follow-up of implant and surgical procedures.



Child mode for reduced dose

Child mode reduces the patient dose remarkably for all programs by reducing the imaging area and exposure values. In the panoramic program the focal layer can also be narrowed.

Quality cephalometry for orthodontics

Our exceptional equipment and advanced software have been designed to meet all your orthodontic needs.

Cephalometric imaging with Planmeca X-ray units

- The functional and easy-to-use head positioner ensures accurate positioning for all cephalometric projections
- The carbon fibre ear posts and nasal positioner are extremely stable, hygienic, and transparent to radiation
- The unit automatically aligns itself to take cephalometric exposures and then selects a corresponding collimator
- Dedicated collimation options for paediatric imaging

Easier and more accurate than ever before

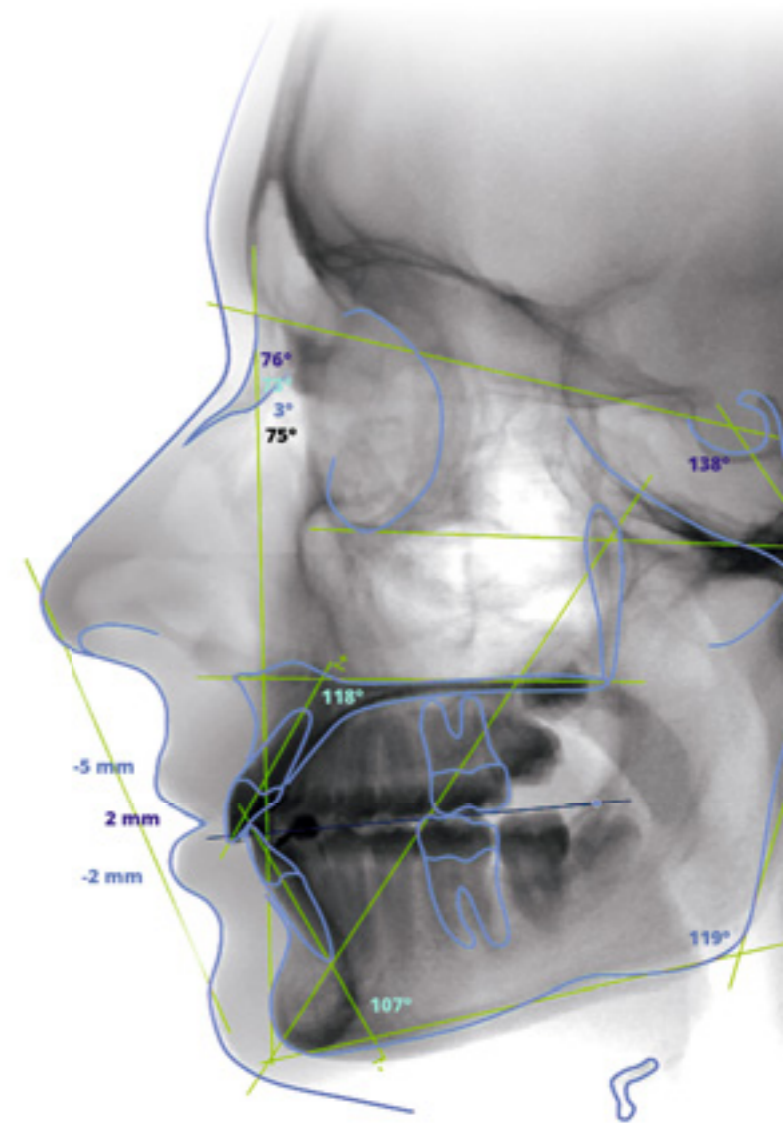

Two equipment options:

One-shot Planmeca ProCeph™ cephalostat

- Effective one-shot cephalostat
- Short exposure time – no motion artefacts, low patient dose
- Image sizes from 18 x 20 cm to 30 x 25 cm
- Available for all Planmeca 3D X-ray units

Scanning Planmeca ProMax® cephalostat

- Digital cephalostat that scans your patient's head horizontally using a narrow X-ray beam with an extremely low effective dose of radiation
- Exceptional flexibility in image formats, with field sizes of up to 30 x 27 cm

Two options for cephalometric analyses:

Planmeca Romexis® Cephalometric Analysis module

Take advantage of the Planmeca Romexis® Cephalometric Analysis module's wide range orthodontic and orthognathic tools.

- Automatic landmark identification
- Tools for creating cephalometric analyses, superimpositions, and surgical treatment plans (VTO) in minutes
- Fully customisable analyses, norms, and reports
- Microsoft Excel export and import function
- Compatible with the Windows operating system

Online automatic analysis service

Acquire cephalometric analyses regardless of time and place with the Planmeca Romexis® automatic cephalometric analysis service.

- Online automatic cephalometric tracing in a few seconds
- Over 50 analyses available for download immediately after tracing
- Direct link from the Planmeca Romexis 2D module for ordering analyses

Easy upgrade from 2D to 3D



Planmeca ProMax® – future proof and a great investment

Planmeca ProMax® 2D is designed with upgradeability in mind. The unit's modular structure allows easy conversion to different imaging modalities, while the software-driven SCARA is extremely flexible, allowing you to benefit from new imaging projections.

Whether you're upgrading your 2D unit to 3D, or adding a cephalometric arm, Planmeca has the right solution for you.

Individual options can be installed before delivery or added later, making Planmeca ProMax the most versatile all-in-one X-ray unit available.



Update options

	Scanning cephalostat	One-shot cephalostat	ProMax 2D S3 2D unit	ProMax 3D Classic CBCT unit
Planmeca ProMax 2D S3	✓	✓		✓
Planmeca ProMax 2D S2	✓		✓	

Planmeca ProOne®

Simplicity at its finest



Planmeca ProOne® is our full-featured panoramic X-ray unit. It has been designed with simplicity in mind and features several cutting-edge innovations – combining extensive diagnostic capabilities and superior image quality into a compact, easy-to-use package.

Easy patient positioning

To minimise imaging errors caused by incorrect patient positioning, Planmeca ProOne and all our other X-ray units support open positioning and convenient side entry for patients – both standing and seated. You can monitor your patient from the front and the side, with positioning further assisted by our triple laser beam system that indicates the correct anatomical positioning points.

User interface provides guidance

Planmeca ProOne is equipped with a full-colour graphical user interface to help guide you through procedures with clear texts and symbols. All settings are logically organised and easy to understand, which speeds up the imaging process and lets you focus on communicating with your patient and positioning them correctly.

Autofocus – for perfect panoramics every time

Our unique **Autofocus** feature automatically positions the focal layer using a low-dose scout image of your patient's central incisors. Landmarks in the patient's anatomy are used to calculate placement, enabling practically error-free patient positioning and dramatically reducing the need for retakes. The result is a perfect panoramic image, every time.

Panoramic imaging	✓
Extraoral bitewing	✓
TMJ imaging	✓
Sinus imaging	✓
Child mode	✓
Autofocus	✓

Optimal imaging programs



Standard panoramic

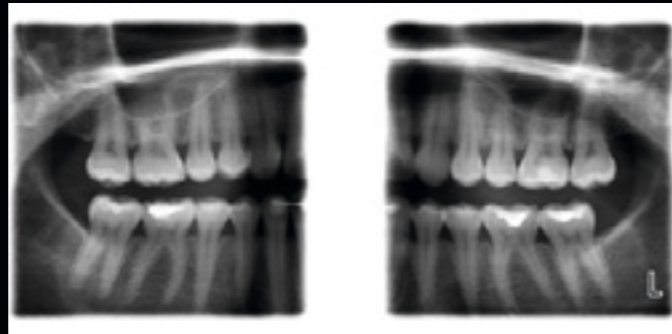

Bitewing

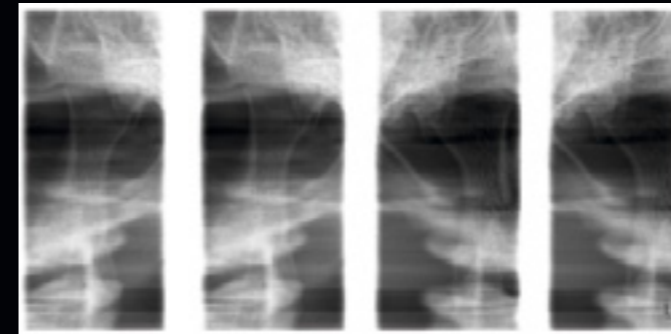

PA TMJ

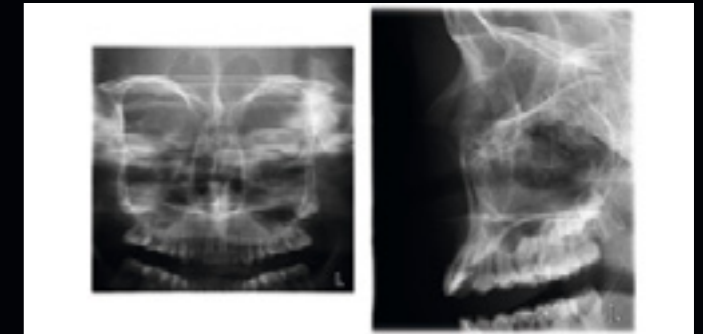

PA Sinus and Lateral non rotational sinus



Horizontal and vertical segmenting for panoramic program



Lateral TMJ

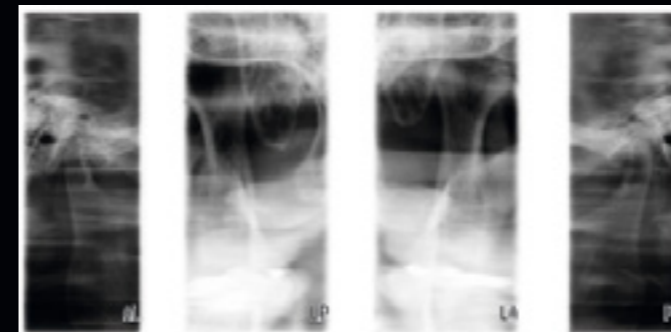

Lateral-PA TMJ

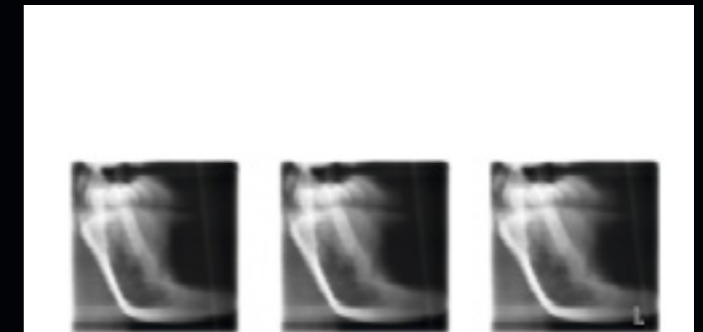

Cross-sections

Planmeca ProOne® offers you a wide variety of imaging programs for different radiographic needs. You can also select the correct exposure formats to minimise the radiation dose for all types of patients and diagnostic purposes.

Imaging programs

Standard: Basic panoramic programs	Standard panoramic Lateral TMJ PA TMJ PA Sinus
Standard	Child (Paediatric) mode for each program to reduce the dose
Optional	Horizontal and vertical segmenting for panoramic program
Optional	Bitewing
Optional: Advanced panoramic programs	Interproximal panoramic Orthogonal (perio) panoramic Lateral-PA TMJ Lateral multiangle TMJ Lateral non rotational sinus Cross-sections Bitewing

Child mode for optimal paediatric imaging

In child mode, the imaging area and exposure values are reduced in all programs and also the focal layer can be narrowed in the panoramic program. The patient dose is reduced remarkably.



Planmeca ProX™

Flexible intraoral X-ray unit

Our advanced **Planmeca ProX™** unit provides easy and precise positioning, a straightforward imaging process and top-quality images in high resolution. It is a highly beneficial and effective 2D imaging option for all dental clinics, making intraoral imaging easier and more reliable than ever.

The premium intraoral X-ray unit

- Optimal images for all diagnostic needs: variable kV and mA
- Quick and easy to use: pre-programmed quick settings, practical design
- Digital-ready
- Integration with the **Planmeca ProSensor® HD** intraoral sensor
- Smooth workflow with the **Planmeca Romexis®** software
- Versatile installation options

Highly adaptable imaging

Planmeca ProX™ adapts to both short-cone and long-cone imaging. For maximum radiation hygiene, an additional rectangular collimator can be adapted to the long cone. The steady X-ray unit arm provides accurate and drift-free positioning of the lightweight tube head.

Quick imaging parameter settings

Planmeca ProX comes pre-programmed with quick settings for different exposure value combinations. Imaging parameters are automatically retrieved according to the selected exposure region and diagnostic need. Values can also be manually adjusted if necessary. Simply select the image receptor to automatically adapt the pre-programmed settings for film, imaging plate or digital sensors – allowing rapid transition to new imaging technologies without reprogramming.

Faster X-ray examinations with digital sensor

Benefit from the the most user-friendly intraoral imaging by combining Planmeca ProX with the Planmeca ProSensor HD intraoral sensor. The captured image is displayed on the screen just seconds after exposure, significantly reducing the time needed for an intraoral X-ray examination compared to conventional film.

Numerous installation options

As every dental clinic is different, it is important to offer various ways to integrate equipment. Planmeca ProX can be installed to match the individual layout and workflow of any type of clinic.



Planmeca ProSensor® HD

Innovative intraoral sensor

Our innovative **Planmeca ProSensor® HD** intraoral sensor offers a unique combination of unparalleled image quality, patient-centred design, and usability. The sensor has been designed to last and provides durability that can be counted on.

Cutting-edge image quality

With a true resolution of over 20 lp/mm, **Planmeca ProSensor® HD** offers real HD image quality. Supporting detailed diagnosis, the advanced imaging sensor with a fibre-optic layer captures sharp, low-noise and high contrast images. The wide dynamic range of the sensor ensures successful results each and every time.

Patient-centred design

To fulfill all intraoral imaging needs, **Planmeca ProSensor HD** is available in three different sizes. The rounded sensor edges make procedures comfortable for patients, with outstanding images ready in a matter of seconds.

Intraoral X-ray unit integration

The seamless integration of **Planmeca ProSensor HD** with the **Planmeca ProX™** intraoral X-ray unit ensures convenience and efficiency at every step. The sensor is easy to connect using just one hand.

High-end usability

The intraoral sensor's magnetic connector makes it easy to attach, with its white colour enhancing visibility to further ease positioning. The sensor's elegant control box is equipped with a colour-coded LED light that provides instant visual feedback of the imaging procedure, while its hermetically sealed housing ensures effective infection control.

Carefree choice

Intraoral sensors are naturally subject to wear and tear in daily use, but **Planmeca ProSensor HD** has been built to last. The sensor's carbon fibre plate prevents bite marks, its shock protection layer guards against minor damage, and its strengthened cable further improves durability.

Each layer carefully designed – for perfect results

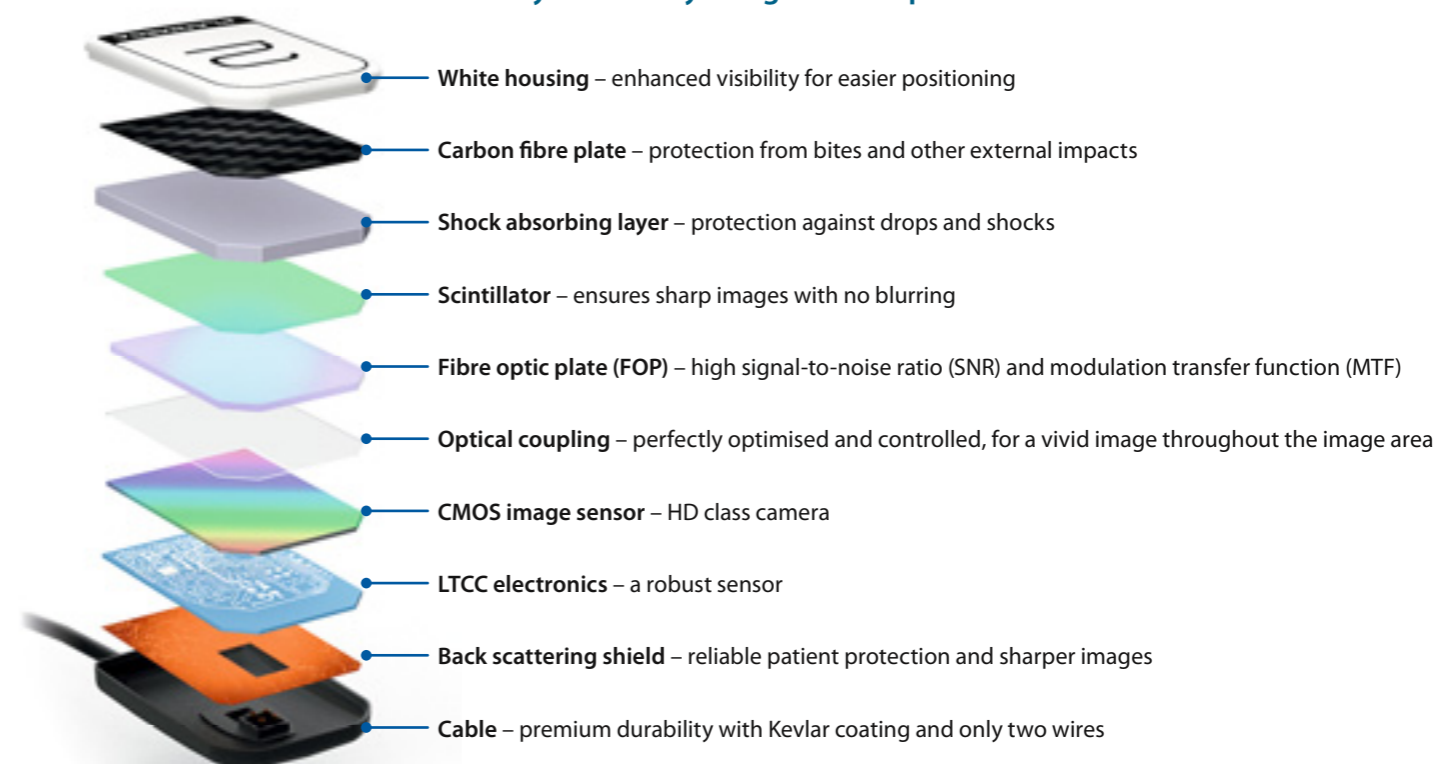

Planmeca ProSensor® HD in a nutshell

- True resolution of over 20 lp/mm
- Sharp and low-noise images with high contrast
- Wide dynamic range
- Three sensor sizes with rounded edges
- Magnetic connector for ease of use
- Colour-coded LED light on control box for instant visual feedback
- Integration with the **Planmeca ProX** intraoral X-ray unit
- Fully compatible with Windows and Mac
- Plug and play USB version
- Five-year warranty program – two years upon registering the product with the opportunity to purchase three additional years

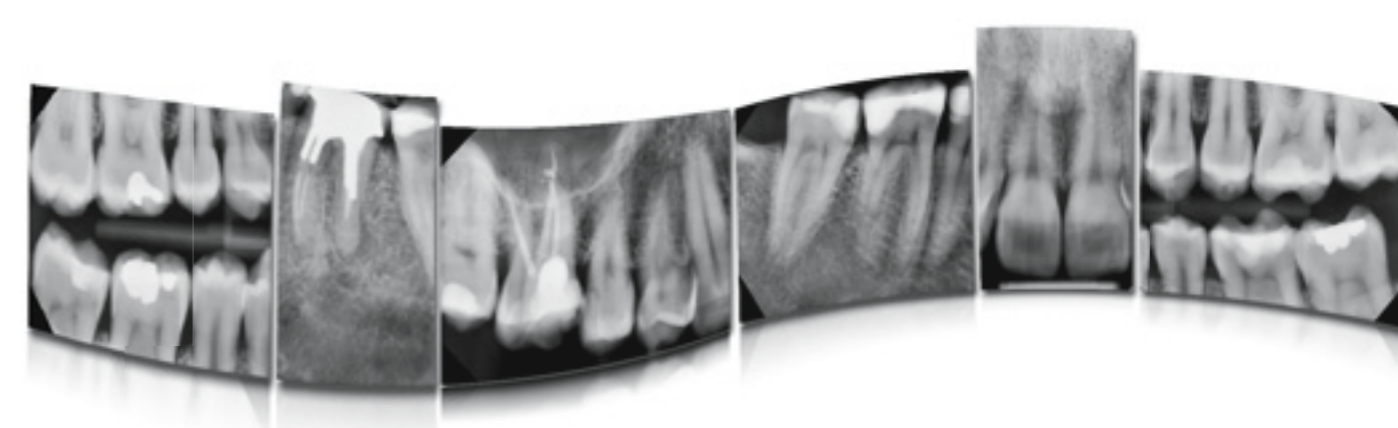

Planmeca ProScanner® 2.0

User-friendly and reliable imaging plate scanner

Our new *Planmeca ProScanner® 2.0* imaging plate scanner is a high-quality option for fast and dependable intraoral imaging. With intelligent design details and outstanding durability, the scanner supports everyday tasks at a dental clinic – providing reliability that is hard to match.

Reliable and dependable

Planmeca ProScanner® 2.0 has been designed to be a seamless part of your clinic's workflow. It is a true workhorse imaging plate scanner that is maintenance-free and extremely durable. The compact scanner fits into any room, helping all clinics prevent downtime and ensure maximum efficiency.

Smart imaging plates

Planmeca ProScanner 2.0 utilises RFID technology for fast scanning and identification. The scanner's high-quality plates can be used numerous times and the integrated eraser instantly prepares them for further imaging. The flexible and bendy imaging plates are very comfortable for patients and available in the most common sizes – 0, 1, and 2.

Easy to use

Planmeca ProScanner 2.0 significantly speeds up your intraoral imaging workflow with its fast scanning process. Just insert the imaging plate, scan it and diagnose the captured image. If the wrong side of the plate is accidentally exposed, it is easy to notice immediately from the captured image.

Planmeca Romexis® software integration

Each imaging plate is equipped with a digital serial number so you can sort, view, and compare images for quality control, as well as count exposures by using the serial number of each plate in the **Planmeca Romexis®** software.



Key benefits of Planmeca ProScanner® 2.0

- Maintenance-free imaging plate scanner designed for active use
- Flexible and durable imaging plates for enduring comfort
- Accelerated workflow due to a streamlined imaging process



Planmeca Romexis® – one software for all your needs

We offer a revolutionary all-in-one software solution for clinics of all sizes. Our world-leading **Planmeca Romexis®** software is the brains behind all of our products, bringing together all the devices at your dental clinic from CAD/CAM to imaging devices and dental units. The easy-to-use Romexis supports the most versatile range of 2D and 3D imaging modalities.

Mac and
Windows
compatible



Share images and expertise online

Planmeca Romexis® Cloud is a secure image transfer service for Planmeca Romexis® users and their partners for sharing image and patient data with any specialist or patient. You can share images and expertise securely with all partners who use Planmeca Romexis, the free Planmeca Romexis® Viewer, or the Planmeca mRomexis™ mobile tablet application.

Versatile possibilities for communication

- External applications, CDs and DVDs are history – images can now be sent directly from Planmeca Romexis®
- The Romexis software and a Planmeca Romexis® Cloud subscription are required to send new cases – recipients only need an email account
- Dental labs can receive CAD/CAM cases without additional software
- Cases can also be viewed with the Planmeca Romexis® Viewer or Planmeca mRomexis™ applications

Visit online.planmeca.com to subscribe and start sending images now.

Receive cases with free Planmeca Romexis® Viewer application

Planmeca Romexis Viewer is a free application that can be exported and sent together with images from Planmeca Romexis.

- Full-featured viewer application
- No installation required
- Mac and Windows support
- Distribute to specialists or patients

Visit planmeca.com/Viewer for downloading Planmeca Romexis Viewer software.



Increased flexibility with Planmeca mRomexis™ tablet application

Use our fast, easy, and light Planmeca mRomexis mobile imaging application to view all your images in the Planmeca Romexis database on a local network, or to carry images with you on your tablet device. You can also use the application to capture 2D X-ray images with Planmeca equipment, or to take photos with the tablet camera.

Download the Planmeca mRomexis application for iOS and Android from the [App Store](#) or [Google Play](#).

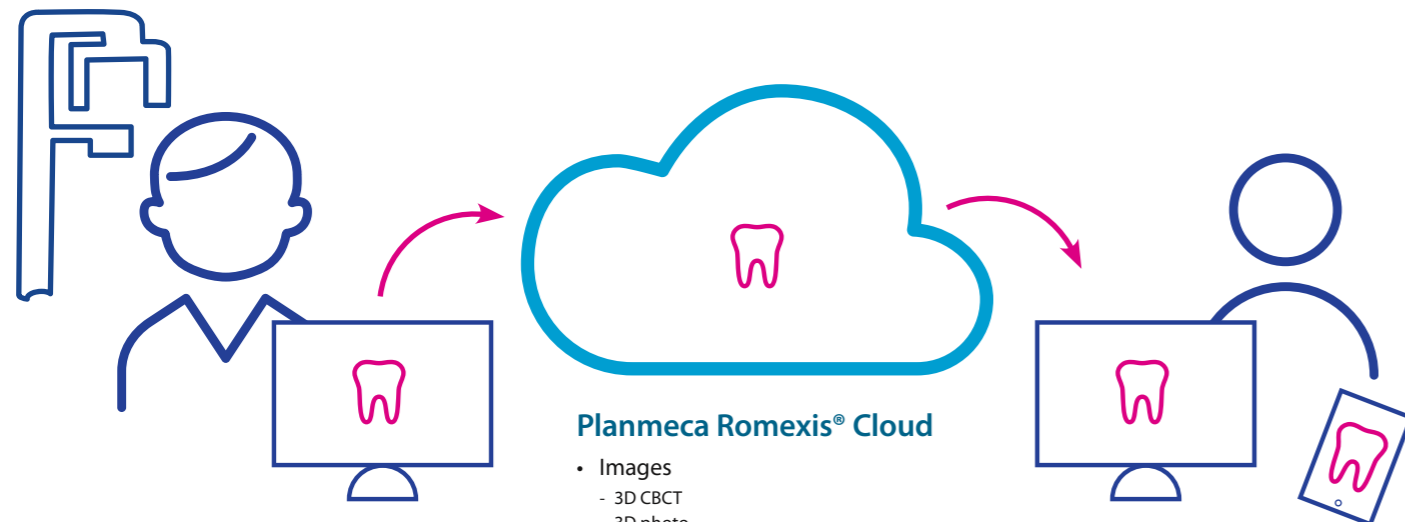

Planmeca Romexis® user

- Radiology center
- General practice

Planmeca Romexis® Cloud

- Images
 - 3D CBCT
 - 3D photo
 - 3D surface scan
 - Panoramic
 - Cephalometric
 - Intraoral
 - Photo
- Referrals
- Interpretations
- Treatment plans

Anybody, anywhere

- General practitioner
- Colleague
- Radiologist
- Specialist
- Dental lab
- Patient

Access to unique X-ray device data

Take the efficiency of your clinic to the next level with real-time information on networked equipment usage and events. Our Romexis® Clinic Management software offers several quality assurance and service benefits for local users, whereas Romexis® Insights allows you to remotely monitor your clinic from anywhere.

Planmeca equipment can be networked to gather valuable data on their use.

- Detailed X-ray log book with dosage and sensor information
- Meet regulatory requirements with automatic recording of image exposure values: kV and mAs
- Enhanced operational planning – exposure counts and modality distribution
- Enhance operational planning – usage hours
- Use detailed event logs to improve quality assurance – including radiation hygiene
- Maximise equipment uptime with fast and accurate trouble-shooting



Planmeca ProMax[®] 2D

Technical specifications

Technical data

Generator	Constant potential, resonance mode high frequency 80–150 kHz	
X-ray tube	D-0545B-P	
Focal spot size	0.5 x 0.5 mm (IEC 336)	
Total filtration	min. 2.5 mm Al equivalent	
Anode voltage	50–84 kV	
Anode current	0.5–16 mA DC	
Exposure time	Pan	2.7–16 s
	Scanning ceph	6.4–9.9 s
	ProCeph	0.1–0.8 s
	Tomo	3 s / frame
SID	Pan	500 mm (19 in.)
	Ceph	170 cm (67 in.)
Magnification	Pan	constant 1.2
	Ceph	1.08–1.13
CCD pixel size	48 µm	
Image pixel size	48/96/144 µm selectable	
CCD active surface	Pan	6 x 147 mm
	Ceph	6 x 295 mm
Resolution (digital)	Pan	max. 9 lp/mm
	Ceph	max. 5.7 lp/mm
Image field (digital)	Pan	14 x 30 cm (5.5 x 12 in.)
	Ceph	24/27 x 18/30 cm (9/10.6 x 7/11.8 in.)
File size, uncompressed (digital)	Pan	4–33 MB
	Ceph	7–16 MB
Line voltage	100–240 V, 50 or 60 Hz	
Regulation	Automatic, ±10 %	
Line current	8–16 A	
Colour	White (RAL 9016)	

Imaging programs

	Planmeca ProMax 2D S3	Planmeca ProMax 2D S2
Standard: Basic panoramic programs	Standard panoramic Lateral TMJ (closed & open) PA TMJ (closed & open) PA sinus	Standard panoramic Lateral TMJ (closed & open) PA TMJ (closed & open) PA sinus
Standard	Child (Paediatric) mode for each standard and optional program to reduce the dose	Child (Paediatric) mode for each standard and optional program to reduce the dose
Optional	Horizontal and vertical segmenting for panoramic program	Horizontal and vertical segmenting for panoramic program
Optional	True Bitewing	Bitewing
Optional: Advanced panoramic programs	Interproximal panoramic Orthogonal (perio) panoramic Lateral-PA TMJ Lateral multiangle TMJ PA multiangle TMJ PA linear sinus Lateral sinus	
Optional: Tomography programs	Digital linear tomography	

Dimensions

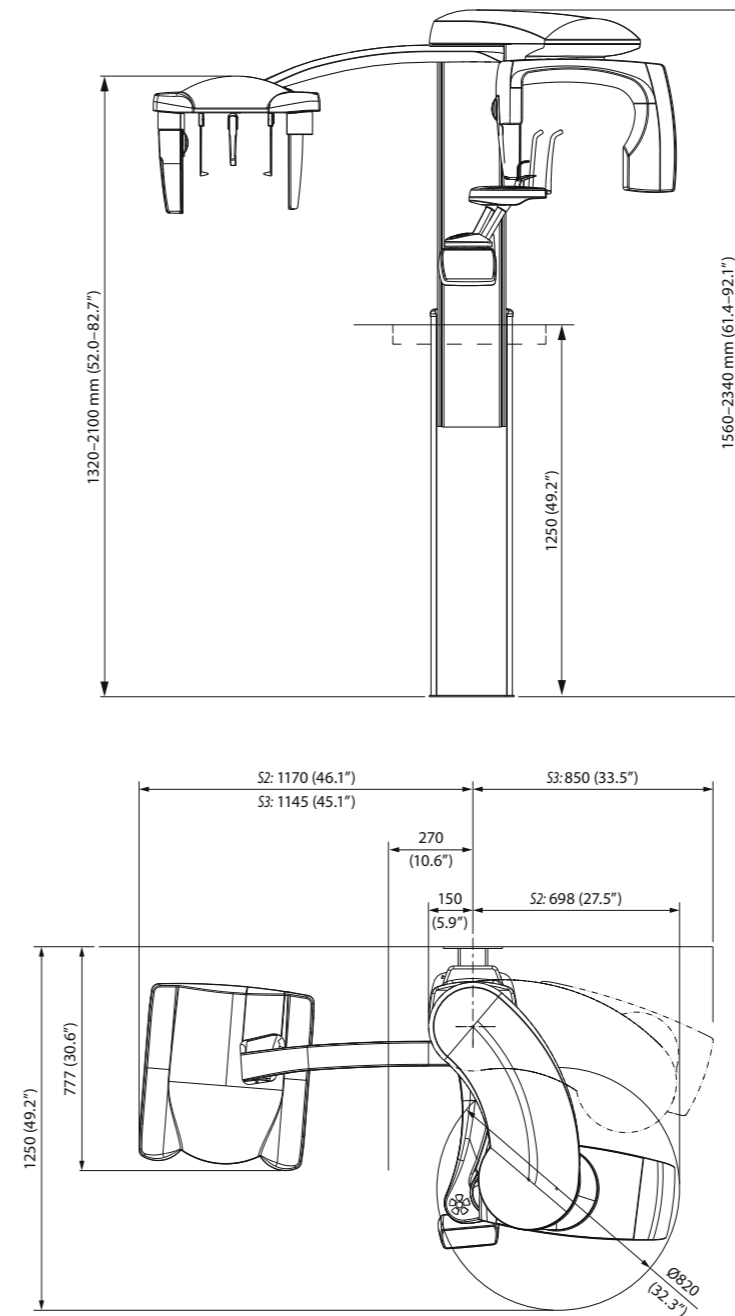

Physical space requirements

	Planmeca ProMax 2D	Planmeca ProMax 2D with cephalostat
Width	100 cm (39.4 in.)	202 cm (79.5 in.)
Depth	125 cm (49 in.)	125 cm (49 in.)
Height*	156–234 cm (61–92 in.)	156–234 cm (61–92 in.)
Weight	113 kg (lbs 248)	128 kg (lbs 282)

*The maximum height of the unit can be adjusted for offices with limited ceiling space.

Stand out with colour



Planmeca ProOne®

Technical specifications

Technical data

Generator	Constant potential, resonance mode high frequency 60–80 kHz
X-ray tube	D-058SBR
Focal spot size	0.5 x 0.5 mm (IEC 336)
SID	480 mm (19 in.)
Total filtration	min. 2.5 mm Al eq.
Anode voltage	60–70 kV
Anode current	2–7 mA DC
Exposure time	2–10 s
Line voltage	100–132 V~ 50/60 Hz, 180–240 V~ 50 Hz
Regulation	±10 % (automatic)
Line current	8–16 A
Power uptake	max: 850 W
Chin rest level	95–178 cm (37.4–70 in.)
Colour	White (RAL 9016)

Imaging programs

Standard: Basic panoramic programs	Standard panoramic Lateral TMJ PA TMJ PA Sinus
Standard	Child (Paediatric) mode for each program to reduce the dose
Optional	Horizontal and vertical segmenting for panoramic program
Optional	Bitewing
Optional: Advanced panoramic programs	Interproximal panoramic Orthogonal (perio) panoramic Lateral-PA TMJ Lateral multiangle TMJ Lateral non rotational sinus Cross-sections Bitewing

Physical space requirements

Width	97 cm (38 in.)
Depth	103 cm (41 in.)
Height	223 cm (88 in.)
Weight	67 kg (148 lbs)

Dimensions

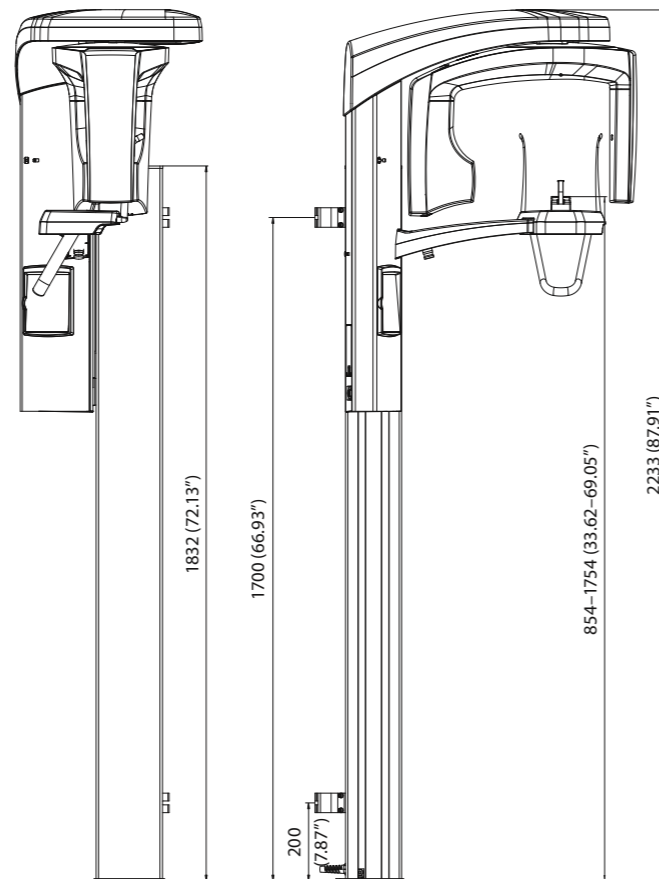
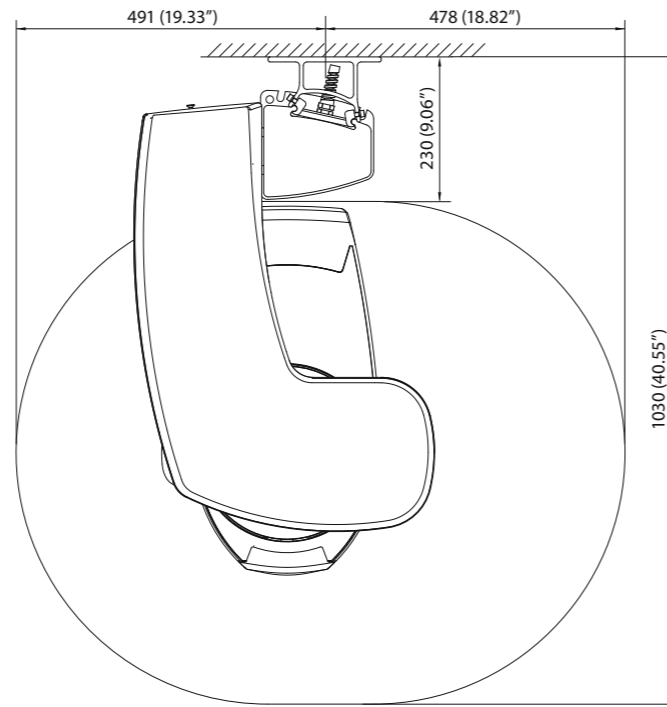

Planmeca ProX™

Technical specifications

Technical data

Generator	Constant potential, microprocessor controlled, operating frequency 66 kHz
X-ray tube	Toshiba D-041SB
Focal spot size	0.4 mm according to IEC 60336
Cone diameter	60 mm (2.36 in.) Rectangular 36 x 45 mm (1.42 x 1.77 in.)
Max. symmetrical radiation field	Ø60 mm at SSD 200 mm Ø60 mm at SSD 300 mm according to IEC 806
Total filtration	min. 2.5 mm Al equivalent at 70 kV according to IEC 60522
Inherent filtration	1 mm Al equivalent at 70 kV according to IEC 60522
Anode voltage	60, 63, 66, 70 kV
Anode current	8, 7, 6, 5, 4, 3, 2 mA
Exposure times	0.01–2 sec., 24 steps
SSD (Source-Skin Distance) Standard/Long	200 mm (8 in.)/300 mm (12 in.)
Mains voltage	100 V~/110-115 V~/220-240 V~, 50/60 Hz
Duty cycle	1:13.5
Electrical classification	Class I Type B
Weight	total 29 kg (64 lbs) tube head with standard cone 4.2 kg (9.3 lbs) tube head with long cone 4.5 kg (10 lbs)
Colour	White (RAL 9016)

Dimensions

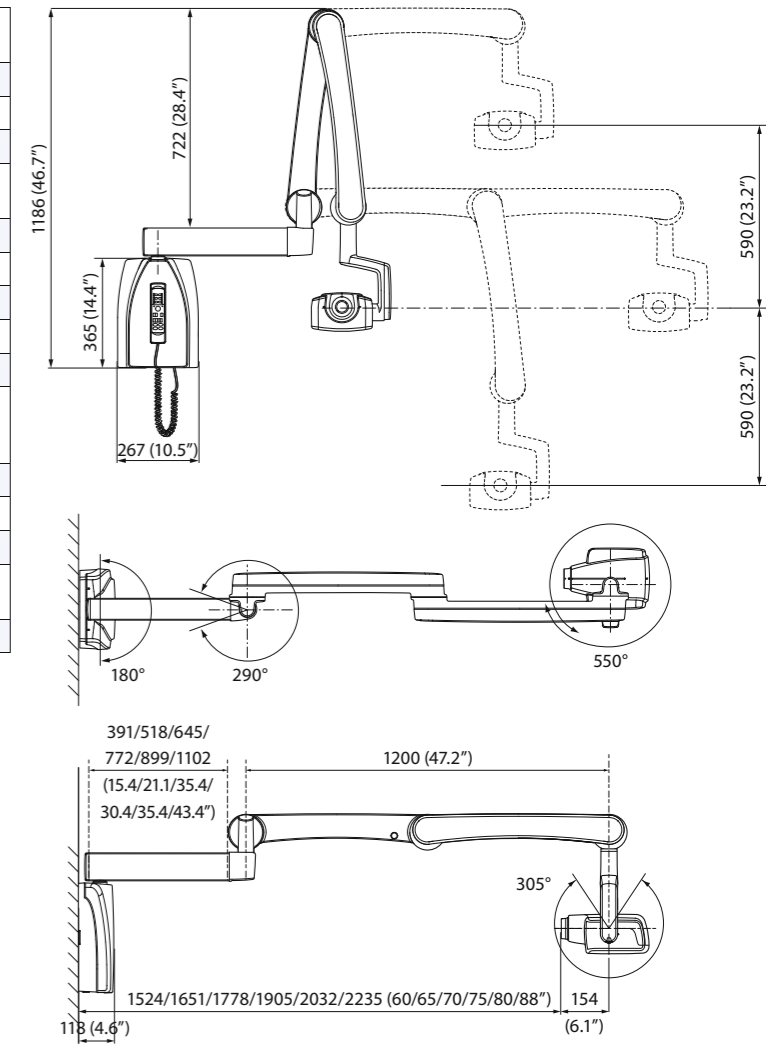

Installation options

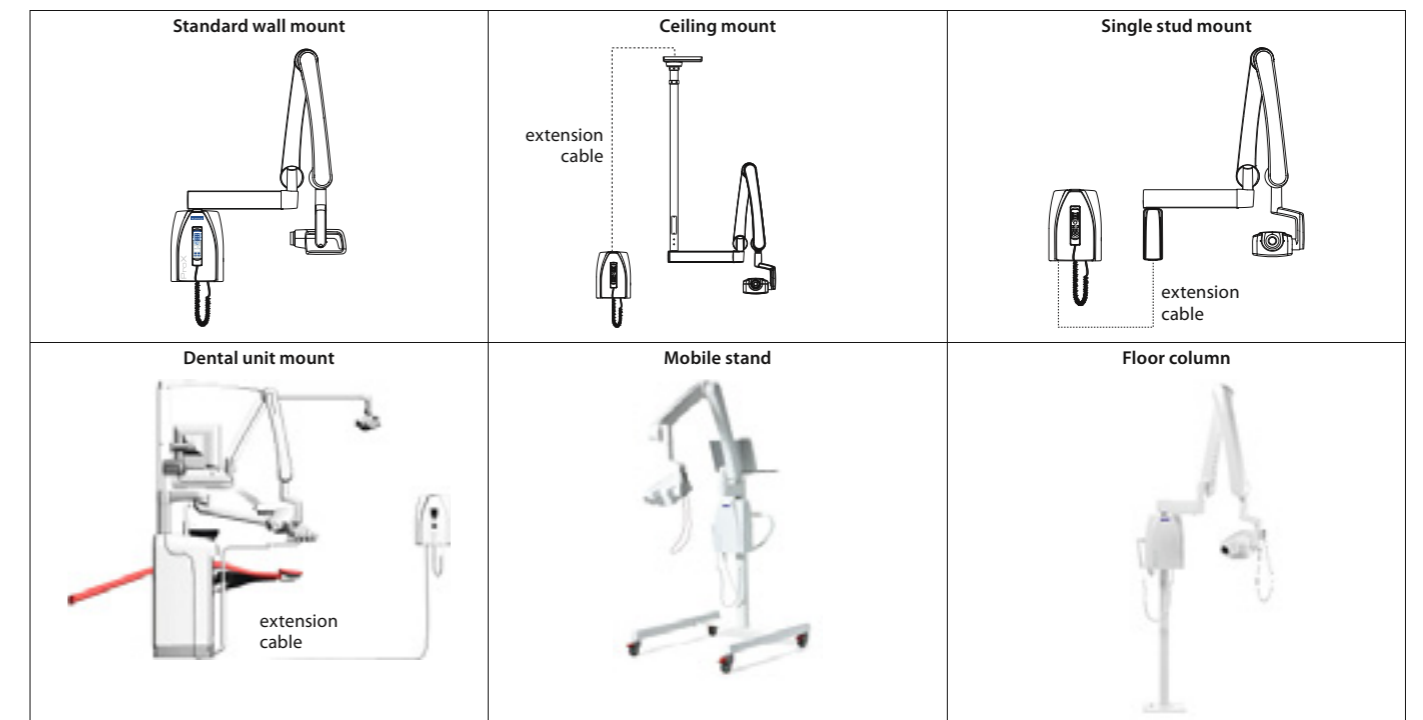

Planmeca ProSensor® HD

Technical specifications

	Size 0	Size 1	Size 2
Sensor size	33.6 x 23.4 mm (1.33 x 0.92 in.)	39.7 x 25.1 mm (1.56 x 0.99 in.)	44.1 x 30.4 mm (1.76 x 1.2 in.)
Active area	25.5 x 18.9 mm (1.0 x 0.74 in.)	30.6 x 20.7 mm (1.20 x 0.81 in.)	36 x 26.1 mm (1.42 x 1.03 in.)
Number of pixels, normal	850 x 629 px	1020 x 690 px	1200 x 870 px
Number of pixels, high	-	2040 x 1380 px	2400 x 1740 px
Pixel size, normal	30 µm x 30 µm		
Pixel size, high	15 µm x 15 µm		
Theoretical resolution	33 lp/mm		
Resolution, normal	17 lp/mm		
Resolution, high	>20 lp/mm		
Interface	USB or Ethernet		
View delay	<5 sec.		

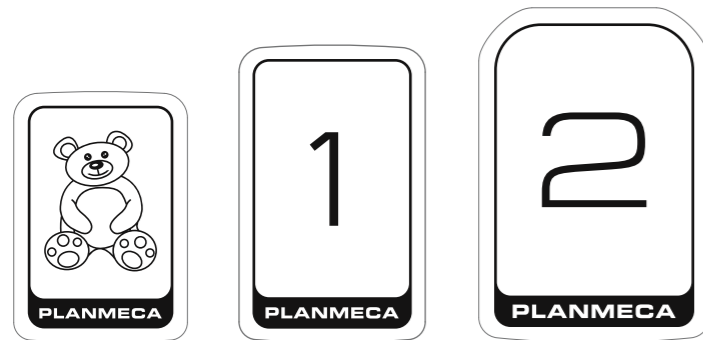

Planmeca ProScanner® 2.0

Technical specifications

Imaging plate sizes	0, 1, 2
Pixel size	30 µm
True resolution	12 lp/mm
Theoretical resolution	16.7 lp/mm
Bits per pixel / Gray scale	16 bit / 65538
Weight	4 kg (8.8 lbs)
Dimensions (H x W x D)	231 x 167 x 216 mm (9.1 x 6.6 x 8.5 in.)
Interfaces	Network
Eraser	Embedded



Planmeca Romexis®

Technical specifications

Supported 2D modalities	Intraoral Panoramic Cephalometric 2D linear tomography Photos Stack images (CBCT slices and panoramic slices)
Supported 3D modalities	3D CBCT 3D photo 3D surface scan
Supported photo sources	Intraoral camera Digital camera or scanner (import or TWAIN capture)
Operating systems	Win 7 Pro (64 bit) / Win 8.1 Pro (64 bit) / Win 10 Pro (64 bit) Win 2008 Server / Win 2012 Server Mac* (OS X or newer) For detailed information please see system requirements of Planmeca Romexis www.planmeca.com *Cephalometric Analysis module, 3D Ortho Studio module and Planmeca PlanCAD Easy are supported on Windows operating systems.
Image formats	JPEG or TIFF (2D images) DICOM (2D and 3D images) STL, OBJ, PLY (3D surface models) TIFF, JPEG, PNG, BMP (imports/exports)
Image size	2D X-ray image: 1–9 MB 3D X-ray image: typically 50 MB–1 GB
Installation options	Client–Server Java Web Start deployment
DICOM 3.0 support	DICOM Import/Export DICOM DIR Media Storage DICOM Print SCU DICOM Storage SCU DICOM Storage SCP DICOM Worklist SCU DICOM Query/Retrieve DICOM Storage Commitment DICOM MPPS
Interfaces	TWAIN Client PMBridge (patient information and images) VDDS (patient information and images) InfoCarrier (patient information)
3 rd party software integrations	Dolphin Imaging NobelClinician Simplant Straumann coDiagnostiX Cybermed N-Liten 3D Diagnostics service 360imaging service

Find all the latest Planmeca news



www.facebook.com/PlanmecaOy



www.planmeca.com/newsroom



Planmeca
Romexis
 all-in-one software

Planmeca Oy designs and manufactures a full line of industry-leading dental equipment, including 3D and 2D imaging devices, CAD/CAM solutions, dental care units and software. Planmeca Oy, the parent company of the Finnish Planmeca Group, is strongly committed to better care through innovation, and it is the largest privately held company in the field.

Follow us on social media!



PLANMECA

Asentajankatu 6 | 00880 Helsinki | Finland | tel. +358 20 7795 500 | fax +358 20 7795 555 | sales@planmeca.com | www.planmeca.com

Images may contain optional items not included in standard delivery. Available configurations and features may have country or area specific variations. Some products displayed above may not be available in all countries or areas. Rights for changes reserved.

Planmeca, All in one, Anomat Plus, Cobra, Comfy, DentoVac, Digital perfection, Economat Plus, Elegant, Flexy, Mini-dent, Perio Fresh, PlanEasyMill, Planmeca 4D, Planmeca ActiveAqua, Planmeca AINO, Planmeca ARA, Planmeca CAD/CAM, Planmeca CALM, Planmeca Chair, Planmeca Clarify, Planmeca Compact, Planmeca Creo, Planmeca Emerald, Planmeca FIT, Planmeca Intra, Planmeca iRomexis, Planmeca Lumion, Planmeca Lumo, Planmeca Maximity, Planmeca Minea, Planmeca Minendo, Planmeca Minetto, Planmeca mRomexis, Planmeca Noma, Planmeca Olo, Planmeca Online, Planmeca PlanCAD, Planmeca PlanCAM, Planmeca PlanClear, Planmeca PlanDesk, Planmeca PlanID, Planmeca PlanMill, Planmeca Planosil, Planmeca PlanPure, Planmeca PlanScan, Planmeca PlanView, Planmeca ProCeph, Planmeca ProFace, Planmeca ProLD, Planmeca ProMax, Planmeca ProModel, Planmeca ProOne, Planmeca ProScanner, Planmeca ProSensor, Planmeca ProX, Planmeca Romexis, Planmeca Serenus, Planmeca SingLED, Planmeca SmartGUI, Planmeca Solanna, Planmeca Sovereign, Planmeca Ultra Low Dose, Planmeca Vision, Planmeca Viso, Planmeca Verity, Planmeca Waterline Cleaning System, Planmeca Xtremity, Proline Dental Stool, ProTouch, Saddle Stool, SmartPan, SmartTouch, Trendy, and Ultra Relax are registered or non-registered trademarks of Planmeca in various countries.